

SCHRITTMOTOR SY28STH

TECHNISCHE DETAILS:

1 Wellenende:

Typ	Winkel	Span./ Phase	Strom/ Phase	Widerst ./Phase	Indukti./ Phase	Halte- moment	An- schlüs- se	Länge
	Grad/ Schritt	V	A	Ohm	mH	g-cm		
SY28STH32 -0674A	1,8	3,8	0,67	5,6	4,2	600	4	31,5
SY28STH45 -0956A	1,8	3,4	0,95	3,4	1,2	750	6	44,5

2 Wellenenden:

Typ	Winkel	Span./ Phase	Strom/ Phase	Widerst ./Phase	Indukti./ Phase	Halte- moment	An- schlüs- se	Länge
	Grad/ Schritt	V	A	Ohm	mH	g-cm		
SY28STH32 -0674B	1,8	3,8	0,67	5,6	4,2	600	4	31,5
SY28STH32 -0956B	1,8	2,66	0,95	2,8	1	430	6	31,5
SY28STH51 -0956B	1,8	4,4	0,95	4,6	1,8	900	6	50,5
SY28STH51 -0674B	1,8	4,56	0,67	6,8	4,9	950	4	44,5

DREHMOMENTVERLAUF

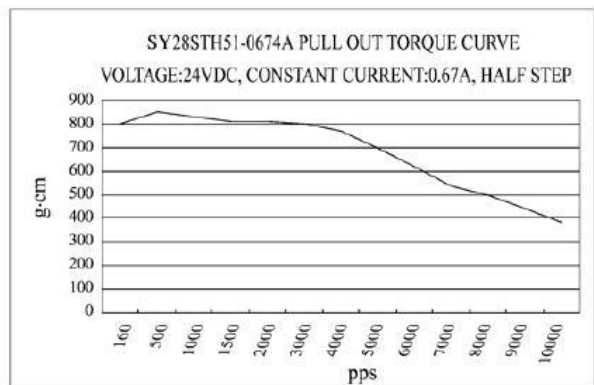
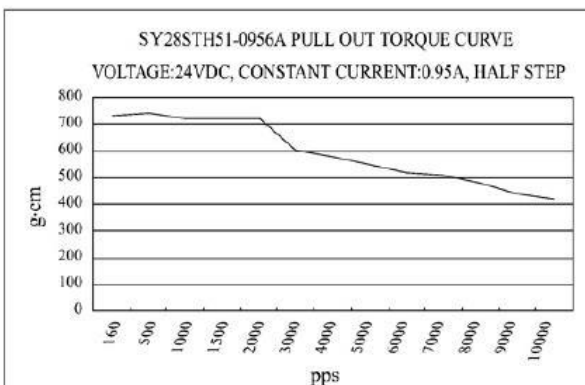
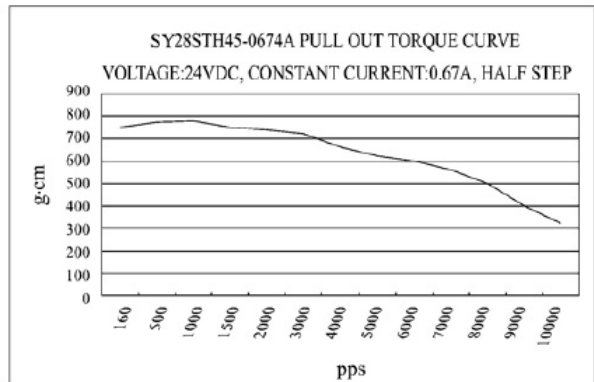
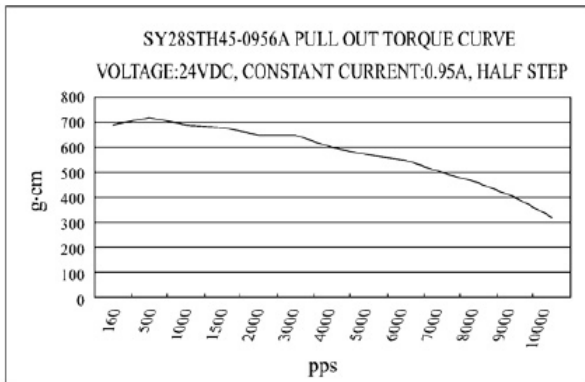
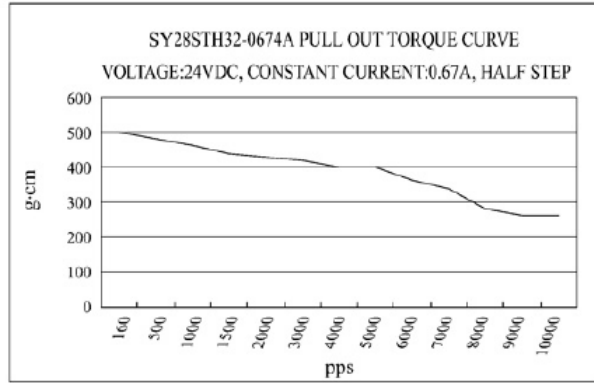
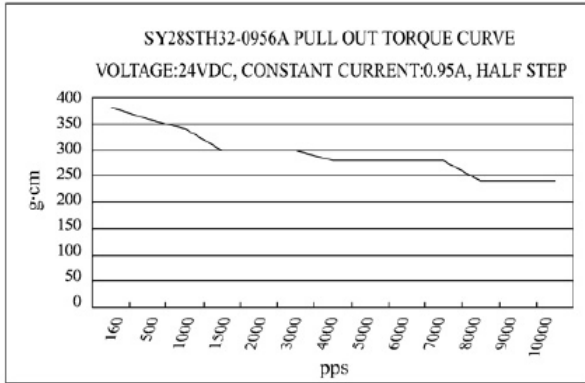

ZEICHNUNG:

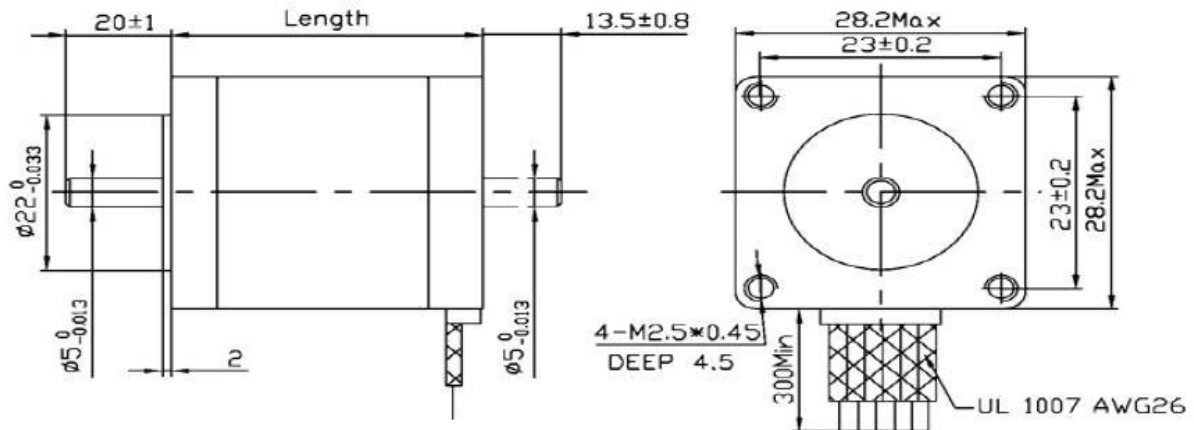

ANSCHLUSSBELEGUNG

